



Chicago Collection

FST, LFC, RH2 pillow back corner group shown in Aaron Silver (Cover 1), Denny Pebble (Cover 2) and Whimsical Bronze (Cover 3).

Colours represented are to be used as a guide only, colour shadings can vary slightly from each roll of fabric/leather hide. Please refer to manufacturers swatch for more colour options.

Extra Flex⁺
Soft, Supportive Seating

22/08/2025

CHICAGO COVER GUIDE - STANDARD BACK

Please use this guide when ordering the following pieces to clarify cover options.

STANDARD BACK

Corner Group: LH2, RFC, FST

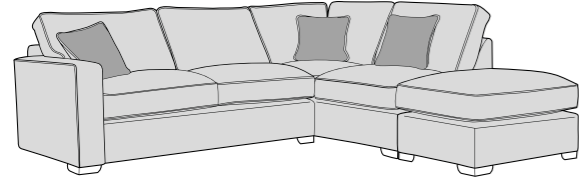

Corner Group: FST, LFC, RH2

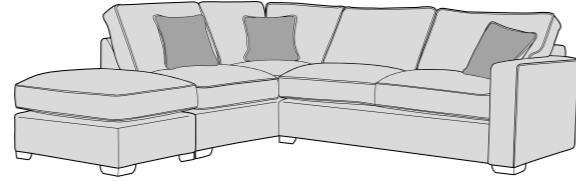

Corner Group: L2S, RFC, FST

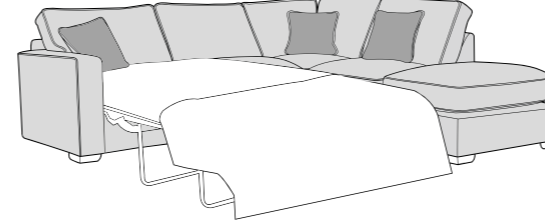

Corner Group: FST, LFC, R2S

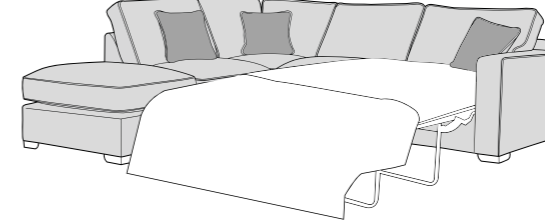

Corner Group: LH2, COR, RH1

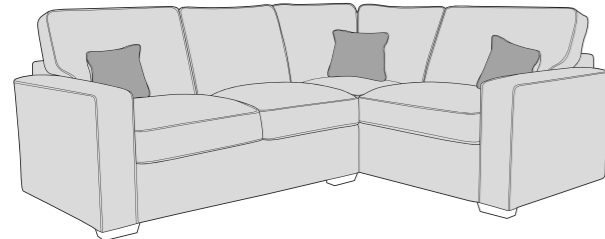

Corner Group: LH1, COR, RH2

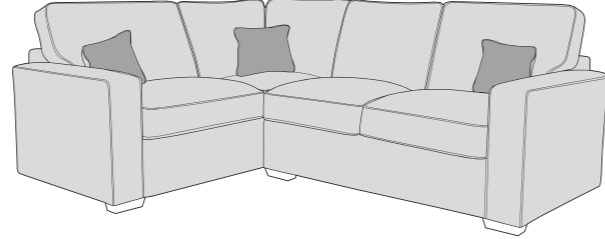

Corner Group: L2S, COR, RH1

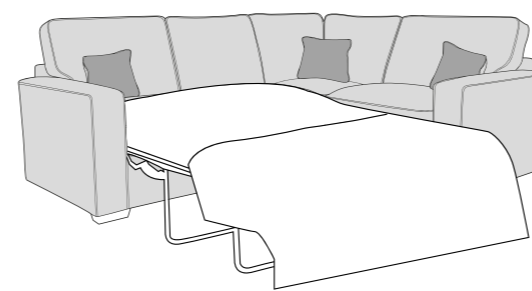

Corner Group: LH1, COR, R2S

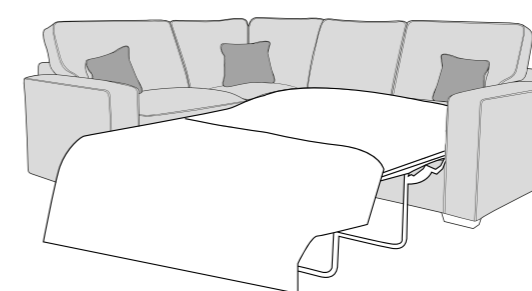

Corner Group: LH2, RTC

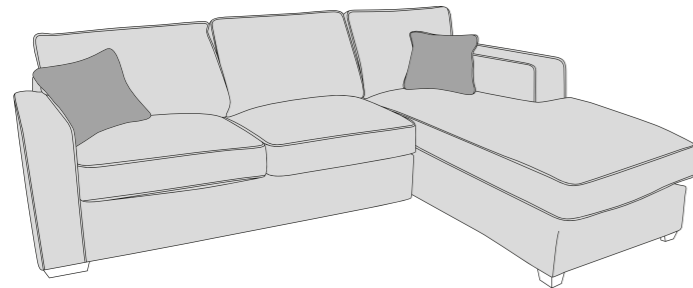

Corner Group: LTC, RH2

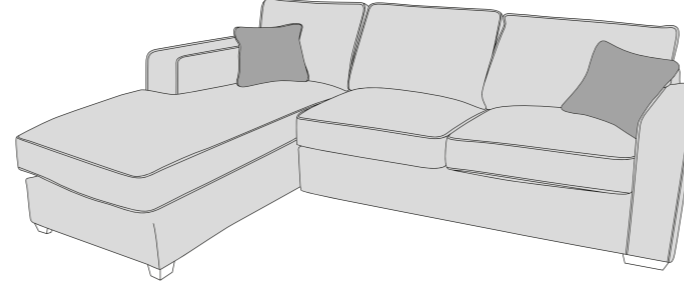

Corner Group: LH2, COR, RH2

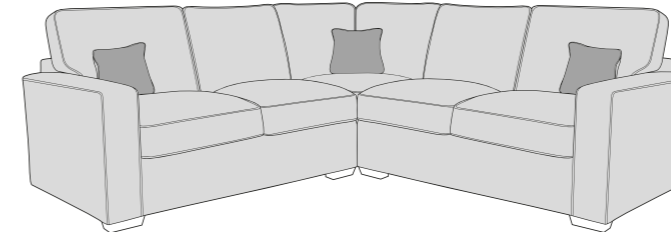

Corner Group: LH1, COR, RH1

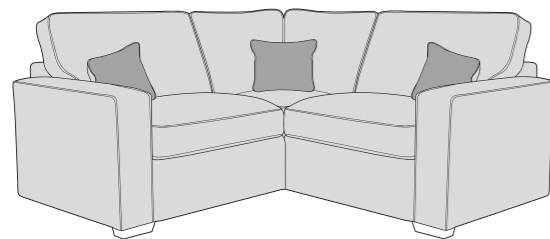

Armless Unit (ALU)

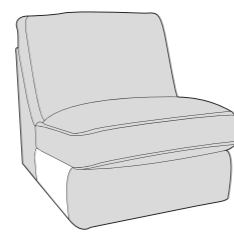

Large Footstool (FST)

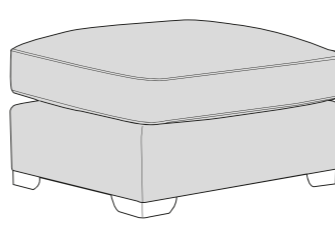

4 Seater Modular Sofa (4MD)

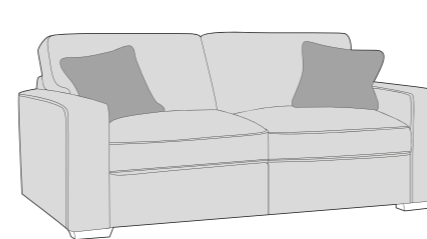

3 Seater sofa (3ST)

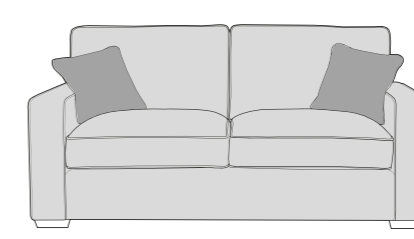

2 Seater sofa (2ST)

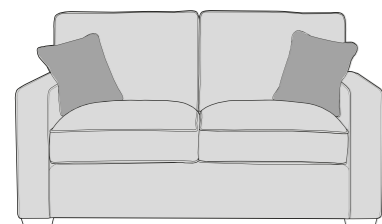

Love Chair (LOV)

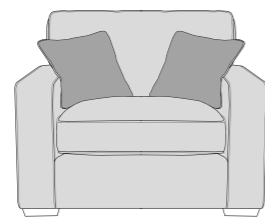

Arm Chair (1ST)

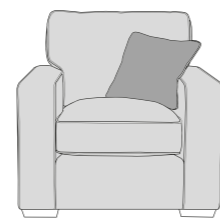

3 Seater Sofa Bed (3SB, 3DB)

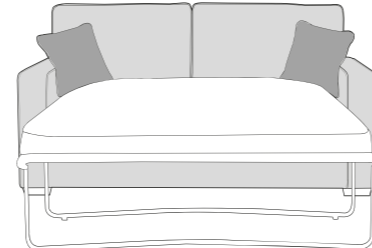

2 Seater Sofa Bed (2SB, 2DB)

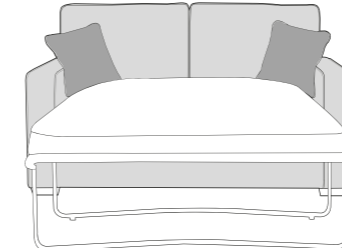

Chair Sofa Bed (1SB, 1DB)

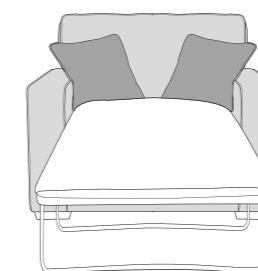

COVER 1
(BODY)

COVER 2
(SCATTER)

Standard Back
Scatter Cushions

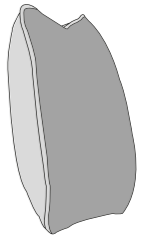

Front = Cover 2
Piping = Cover 1
Back = Cover 1



MANUFACTURER MEMBER



CHICAGO COVER GUIDE - PILLOW BACK

Please use this guide when ordering the following pieces to clarify cover options.

PILLOW BACK

LH2, RFC, FST Group

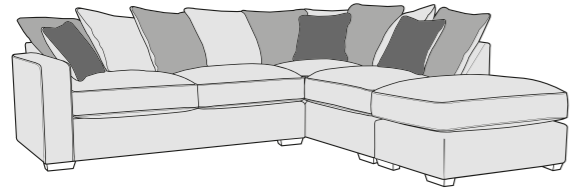

FST, LFC, RH2 Group

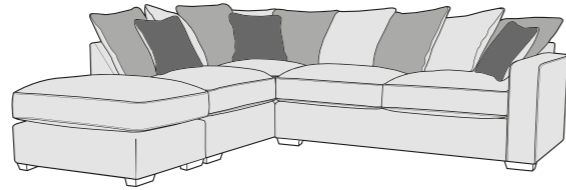

L2S, RFC, FST Group

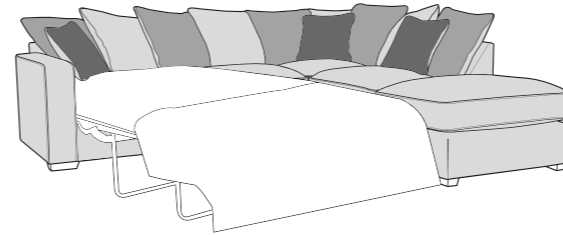

FST, LFC, R2S Group

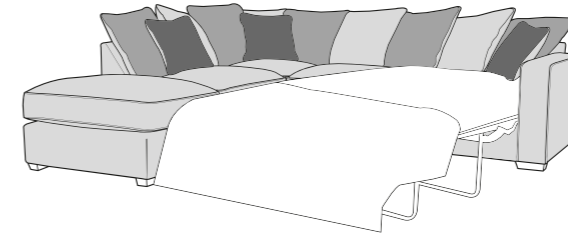

LH2, COR, RH1 Group

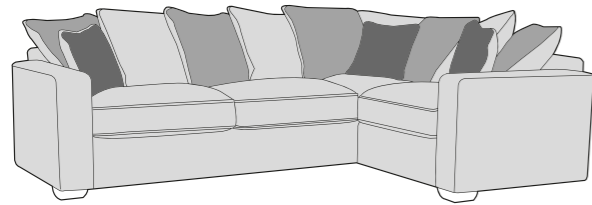

LH1, COR, RH2 Group

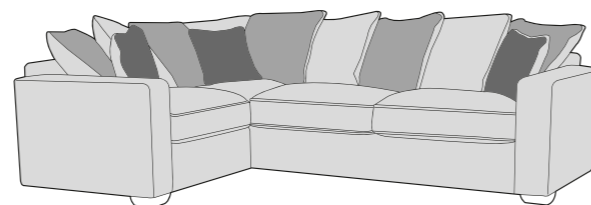

L2S, COR, RH1 Group

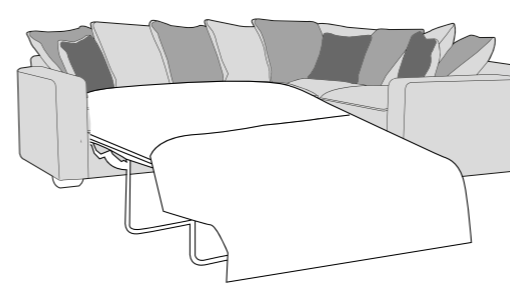

LH1, COR, R2S Group

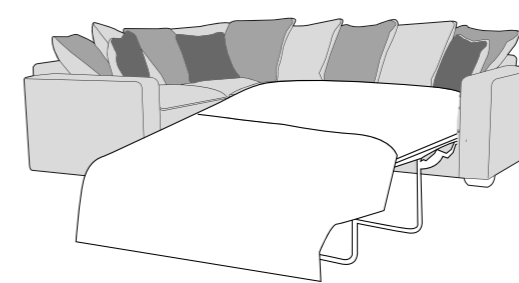

Corner Group: LH2, RTC

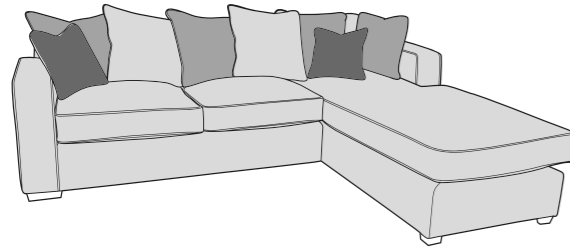

Corner Group: LTC, RH2

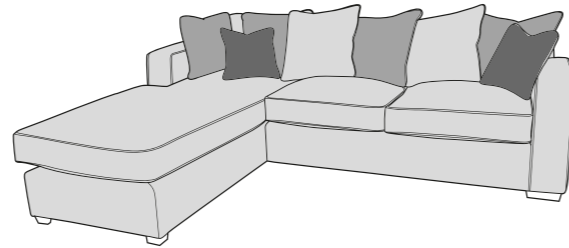

LH2, COR, RH2 Group

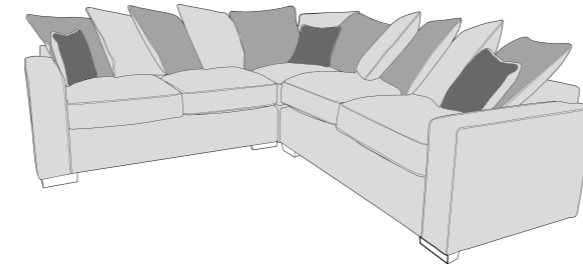

LH1, COR, RH1 Group

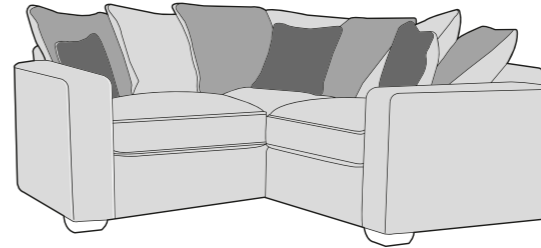

Armless Unit (ALU)

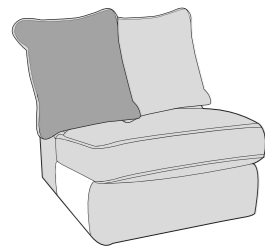

Large Footstool (FST)

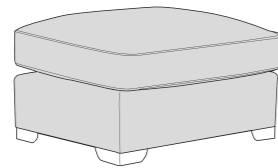

4 Seater Modular Sofa (4MD)

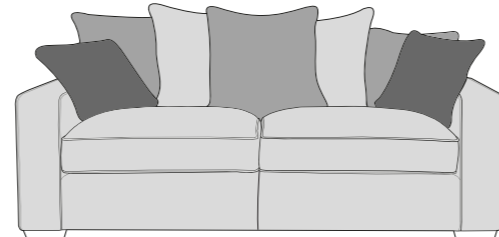

3 Seater Sofa (3ST)

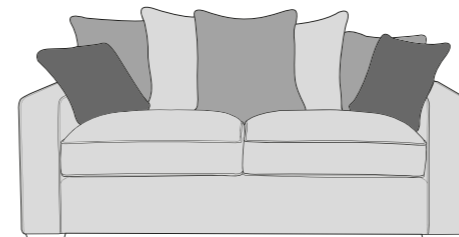

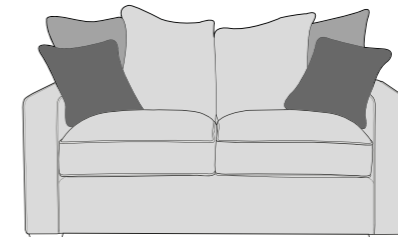

2 Seater Sofa (2ST)

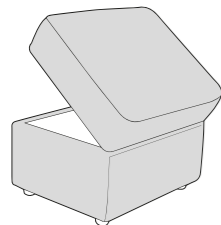

ACCENT PIECES

Storage Footstool (FSS)



-  **COVER 1**
(BODY)
-  **COVER 2**
(PILLOW)
-  **COVER 3**
(SCATTER)

Pillow Back Cushions

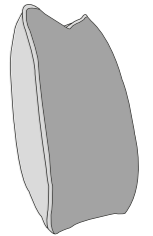

Front = Cover 2
Piping = Cover 1
Back = Cover 1

Pillow Back Scatter Cushions

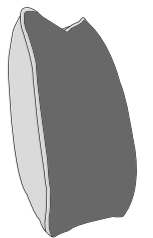

Front = Cover 3
Piping = Cover 1
Back = Cover 1



MANUFACTURER MEMBER



CHICAGO DIMENSIONS (CM)

AVAILABLE PIECES	HEIGHT 1	WIDTH 2	DEPTH 3	SEAT HEIGHT 4	SEAT DEPTH (STD) 5	SEAT WIDTH 6	ACCESS DIAGONAL 7	WEIGHT (KG)	SCATTER CUSHION NO.
LH2, RFC, FST GROUP or RH2, LFC, FST GROUP	96	276	247	55	55	N/A	N/A	120	3 Scatters, 1 Bolster
L2S, RFC, FST GROUP or R2S, LFC, FST GROUP	96	247	250	55	55	N/A	N/A	128	3 Scatters, 1 Bolster
LH2, COR, RH1 or LH1, COR, RH2 GROUP	96	275	197	55	55	N/A	N/A	111	3 Scatters, 1 Bolster
L2S, COR, RH1 or R2S, COR, LH1 GROUP	96	247	197	55	55	N/A	N/A	109	3 Scatters, 1 Bolster
LH2,RTC or LTC,RH2 GROUP	96	280	161	55	55	N/A	N/A	80.5	2 Scatters, 1 Bolster
LH2, COR, RH2 GROUP	96	275	275	55	55	N/A	N/A	128	3 Scatters, 2 Bolsters
LH1, COR, RH1 GROUP	96	197	197	55	55	N/A	N/A	94	3 Scatters
4 SEATER MODULAR SOFA (4MD)	96	TBC	98	55	55	TBC	N/A	TBC	2 Scatters, 2 Bolsters
LH2/RH2 UNIT	96	182	98	55	55	162	205	49	1 Scatter, 1 Bolster
L2S/R2S BED ACTION	96	154	98	55	55	133	178	57	1 Scatter, 1 Bolster
LH1/RH1 1 SEAT ARM UNIT	96	104	98	55	55	80	138	32	1 Scatter
LFC/RFC UNIT	96	177	98	55	55	140	198	53	2 Scatters
LTC/RTC UNIT	96	100	161	55	112	79	188	31.5	1 Scatter
4ML/4MR UNIT	96	TBC	98	55	55	TBC	TBC	TBC	1 Scatter, 1 Bolster
ALU (ARMLESS) UNIT	96	80	98	55	55	80	120	21	N/A
COR (CORNER) UNIT	96	93	93	55	55	93	125	30	1 Scatter
FST (LARGE FOOTSTOOL) UNIT*	55	98	73	56	55	N/A	115	18	N/A
3 SEATER SOFA (3ST)	96	198	98	55	55	160	217	56	2 Scatters, 2 Bolsters
2 SEATER SOFA (2ST)	96	171	98	55	55	133	198	49	2 Scatters, 1 Bolster
LOVE CHAIR (LOV)	96	130	98	55	55	90	161	44	2 Scatters
ARM CHAIR (1ST)	96	98	98	55	55	60	133	34.5	1 Scatter
SOFA BEDS - STD BACK ONLY									
3S (140CM SOFA BED) STANDARD	96	188	98	55	55	149	208	82.5	2 Scatters, 2 Bolsters
2S (120CM SOFA BED) STANDARD	96	168	98	55	55	129	193	74.5	2 Scatters, 1 Bolster
1S (80CM SOFA BED) STANDARD	96	130	98	55	55	90	161	64.5	2 Scatters
3D (140CM SOFA BED) DELUXE	96	188	98	55	55	149	208	104	2 Scatters, 2 Bolsters
2D (120CM SOFA BED) DELUXE	96	168	98	55	55	129	193	95	2 Scatters, 1 Bolster
1D (80CM SOFA BED) DELUXE	96	130	98	55	55	90	161	88	2 Scatters
OPEN DEPTH OF SOFA BEDS 226CM									
ACCENT PIECES									
STORAGE FOOTSTOOL (F)	45	63	50	N/A	N/A	N/A	75	12.5	N/A

- * Hardwood & composite board frame.
- * Dowelled, screwed, glued & stapled joinery.
- * Gold, Chrome & Wood foot options.

- * ExtraFlex+ high comfort seat cushions.
- * Fibre filled backs for added comfort.

- * Serpentine seat springs & silent wire.
- * Elasticated back webbing.

SOFABEDS: 2 SLEEP OPTIONS

STANDARD ACTION & FOAM MATTRESS

A three fold metal action with a sprung 'polyprop' base. Complemented by a high performance foam mattress. For occasional use only.

Mattress Thickness: 6cm

Mattress Length: 185cm

3 fold action is 140Kg total max occupancy weight

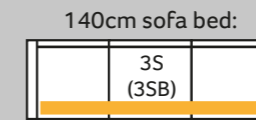

140cm sofa bed: 3S (3SB) Mattress Width:133cm

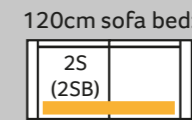

120cm sofa bed: 2S (2SB) Mattress Width:113cm

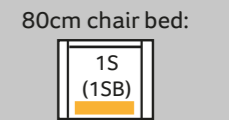

80cm chair bed: 1S (1SB) Mattress Width:73cm



DELUXE ACTION & SPRUNG MATTRESS

A two fold metal action with beech slats. Complemented by a deluxe sprung mattress. For everyday use.

Mattress thickness: 11.5cm

Mattress Length: 183cm

2 fold action is 160Kg total max occupancy weight

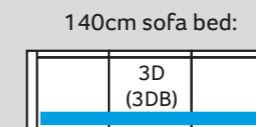

140cm sofa bed: 3D (3DB) Mattress Width:132cm

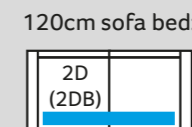

120cm sofa bed: 2D (2DB) Mattress Width:114cm



80cm chair bed: 1D (1DB) Mattress Width:76cm



Sofa beds available as standard back only

DIMENSION GUIDE

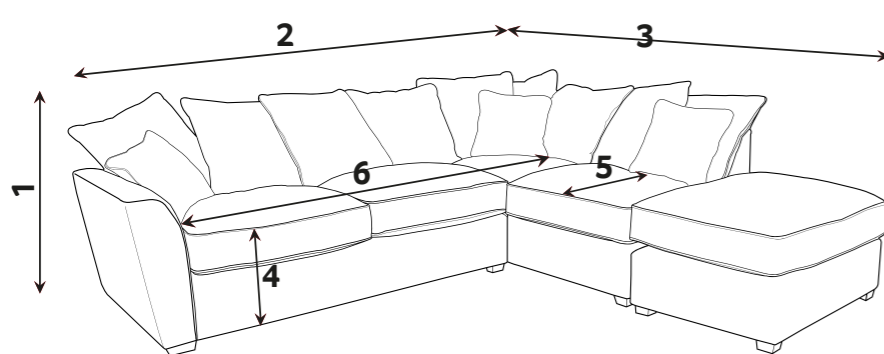

- 1 - HEIGHT
- 2 - WIDTH
- 3 - DEPTH
- 4 - SEAT HEIGHT
- 5 - SEAT DEPTH (STD & PILLOW)
- 6 - SEAT WIDTH

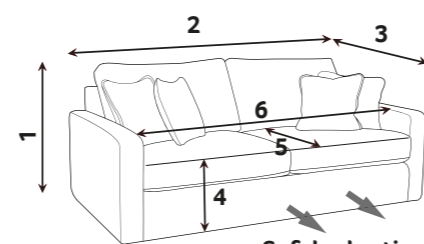

Sofabed action

Check the diagonal access dimension to ensure furniture will fit in your home.

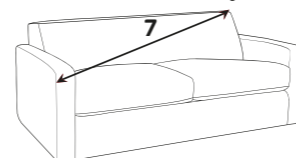

7 - DIAGONAL ACCESS

Illustrations used for reference only.

Extra Flex+

Soft, Supportive Seating

A high density foam base seat interior with a hand-rolled carded fibre, channelled topper which provides both softness and support.

CARE GUIDE

Extraflex seat cushions should be **plumped up on a regular basis** to help maintain the aesthetical appeal of your upholstery, the plumping of cushions is essential to help retain the comfort and softness of any piece of upholstered furniture.

To improve the longevity of your hand-made furniture, we recommend rotating cushions (where applicable).

For further information on maintaining your furniture please refer to the care guide located under the seat platform.

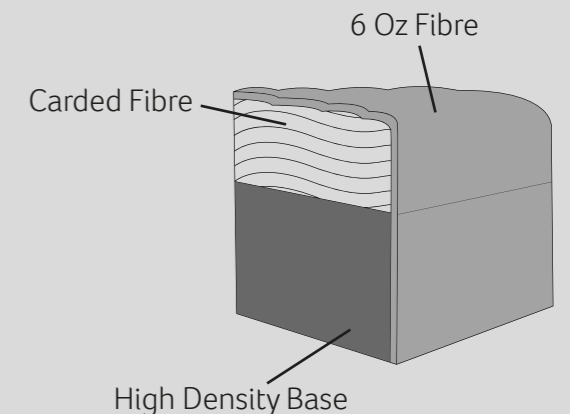

- Beech (Light)
- Mid Oak
- Brown (dark)
- Chrome
- Gold

FOOT OPTIONS:



Wood is a natural product and will vary in shade/colour from item to item. Feet may require fitting.



See terms & conditions

Please note : All dimensions are approximate. Allow tolerance of +/- 2.5cm.

22/06/2026